

Programming Basics

Writing code is never extremely easy; however, it is also not as difficult as you might imagine. The basis of all programming is simple logic, and programming languages use lots of simple math symbols and English words. So, if you're comfortable with things like equals signs, some very basic algebra, and a smattering of English words, you'll probably do just fine. This chapter is by necessity far shorter than it could be. Learning all of the intricacies of writing code in even a single programming language, much less multiple languages, takes years of study. However, you can easily learn some of the basics, read documents, ask questions on user forums, and use what other people have created, and then find yourself able to create projects and designs within a short amount of time. With that in mind, this chapter is a simple introduction to the fundamentals that the rest of this book relies on.

There are a few types of readers using this book. The first says, "I just want it to work." For you, this chapter will explain just enough that you'll be able to follow along with the examples in this book and the ones that you find online, and be able to modify them slightly to get them to do what you need them to do. You'll definitely want to read this chapter, probably more than once, but know that I understand your predicament. I was there once myself. You should know, though, that simply copying and pasting code with no understanding of what it's doing is a very easy way to become seriously frustrated. You should know at least the basics of what your code is doing. Another kind of reader says, "I want it to work, and I want to know why it works." For you, this chapter will be an introduction. You'll probably read it, read some examples, and come back to this chapter again later. That's a good thing. You'll probably also want other books soon. Some of the best are listed in [Chapter 18](#). Another kind of reader may be familiar with some material covered in this book but not others. For you, this chapter will probably be a review and may not even be necessary, but you might want to flip through it just in case you're not familiar with the Processing or Arduino languages or some of the basics of C++. If you are familiar with the basics of all of these languages, then you might want to skip ahead to the chapters on the tools themselves or to [Chapter 5](#) for some more advanced material on programming. Whichever type

you are, you should read enough to understand what the code listings in the rest of the book describe.

Why You'll Read This Chapter More Than Once

In all likelihood, the first time you read this chapter, some of it will not make sense. That's perfectly normal and to be expected. As you read through the rest of this book, when you have questions, return to this chapter. There's no substitute for seeing how code functions within the context of something interesting to you. Some of the ideas might not make sense at first, but after seeing them put into practice, being patient, and hacking at them, you'll find that none of this is wildly complicated. Don't be afraid when you don't understand something, don't be afraid to look back at this chapter, and above all, don't be afraid to copy code from this book and change it until it breaks. Hacking at code, taking stuff that works, breaking it, and then figuring out why it breaks is the best way to understand. Of course, the goal throughout this book is to try to provide code that will just work and satisfy the first kind of reader, those of you who simply want it to work and be done with it. In either event, though, this is going to require some patience, because it simply won't *make sense* the first time through. With a little bit of patience, though, and the willingness to experiment, fail, and try again, you'll find that this isn't all that difficult.

The Nature of Code

Throughout this chapter, you'll be learning about programming—writing code, to be more exact—so it's important to know not only what code *is* but how it fits into the process of creating a program. There are a few key terms that you should understand before starting to program:

Code

Code is a series of instructions that a computer will execute when the code is run. It is written in a programming language that, like natural languages, is essentially a contract between two parties. In the case of code, though, the two parties are the programmer and the compiler. You'll learn more about a compiler shortly; for the moment, we'll just think of it as the listener who understands our code. Code can be as simple as adding two numbers or as complex as rendering an animation. What matters is that you write correct instructions to the compiler using a programming language and a text editor of some sort and then tell the compiler what files contain the instructions. Writing code is typing code instructions into a text file that will later be passed to a compiler of some sort. To write a program can mean writing source code from scratch, or it can mean putting several programs together and creating a way for them to communicate. This can also mean configuring prebuilt projects. Creating applications and code doesn't always require

writing code, but if you have this book, then you're probably interested in creating code.

Files

Code is stored in text files that usually any text editor can open. These files contain your code and nothing else. For larger and more complex projects, you can link multiple files together. Sometimes, larger projects will have many hundreds of code files that will all be linked together to create the sum of the code for the application. Arduino projects use *.pde* files and sometimes *.c* files. Processing projects also use *.pde* files and sometimes *.java* files. openFrameworks projects use *.cpp* and *.h* files. In each case, the different file types do different things and have different purposes that you'll learn more about later in this book.

Compiler

A compiler is a program that takes a code file (or many code files) and turns it into a series of instructions that a computer will run as a program. Most modern computers do not directly process any instructions that you write; instead, you ask a compiler to turn your code into machine instructions. The compiler optimizes machine instructions for the computer to run very quickly, but they would be very difficult for a person to write, so the better step is to write code in a more human-friendly way and convert it to machine-friendly instructions. This means that when you write code for an Arduino controller or write some Java code, you don't simply run that code; you compile it and have the compiler create an executable file that your computer can run. You can imagine the process of writing code as a series of translations in which you tell the compiler what you want to do with the program that it will create in a high-level programming language like Processing or C++ and the compiler then creates a machine language file that will run that file.

Executable

An executable is a file that can be run as an application. It is the result of writing code and compiling it. Sometimes the terms *application* and *executable* are used interchangeably, but they're not the same. An application may consist of many executable files, or it may consist of only one. In either case, for the kinds of projects you'll be learning to build in this book, you'll always have an executable.

Now you're ready to get started writing your own code.

Variables

Looking at variables is a good place to start. Everyone remembers variables from their first algebra classes. You might have seen something like this written on a blackboard or whiteboard:

$$x = 5$$

That says, "There's something called *x*, and it is equal to the number 5." Variables in computing are very similar. They represent something, and in fact they always

represent a certain kind of something. That’s a little different than the algebra example because that example didn’t need to say that `x` is going to be a number; it just says, “`x` is a number.” If you wanted to use code to make a number called `x` and use it as a variable, you would do it like this:

```
int x;
```

The `int` indicates (or *sets*) the type of the variable. You can’t just make any type of variable; you have to make specific kinds of variables. The kind of variable is called its *type*; types are dealt with a lot more in the next section, so for right now, let’s concentrate on getting the basics of variables down.

```
int x = 5;
```

This code creates a variable named `x` that is an integer and has the value of 5. What this means is that somewhere in your computer’s memory there is something called `x` that is storing the value 5. You can set the value of `x` right away, as in `int x = 5`, or create it and leave it for later use, as in `int x`. Look at another example:

```
int y = 10;
int x = 5;
int z = x + y;
```

This snippet shows some code that creates variables, gives two of them values, and sets a third variable’s value to be the sum of the first two.

Simple Types

In the platforms covered in this book, all variables are *typed*. This means that they have a type that tells the computer what sorts of things are going to be stored in the variable. This is because numbers, letters (usually called *characters*), and `true/false` (called *boolean* values) all require different amounts of space to store and move around.

Here are some of the most common types that you’ll encounter in each of the programming languages in this book.

int

This is the datatype for integers, which are numbers without a decimal point, like 2 or 20,392. Now, we’re about to run into our first real problem in this chapter: there are three programming languages used in this book; they all have similar things, but they sometimes work just a little bit differently. In Processing, integers can be as large as 2,147,483,647 and as low as -2,147,483,648. In Arduino and C++, the languages that openFrameworks (oF) uses, things work a little differently, and understanding why requires a quick explanation of signed and unsigned variables. The next small section explaining signed and unsigned variables might be a bit heavy at first, so you may want to skim over it the first time, particularly if you’re more interested in working with Processing.

Signed versus unsigned

As mentioned earlier, variables need to be declared with a type because the computer needs to know how much space they will take up. That means that sometimes an int is 4 bytes or 32 bits of information all the time and that it can store 4 bytes worth of information. So, what happens when you need a negative int? Well, you have to store whether it's negative or positive, and the way you do that is by moving all the values of the int down into the negative values. For the moment, you'll see how this works in C++, the language that oF uses, and then the rest of the languages will be addressed. In C++, where the int represents a value in between $-2,147,483,647$ to $2,147,483,647$, if you have an int that is never going to use a negative number, you can use an unsigned int that stores anything from 0 to $4,294,967,295$. This is what's called having *signed* or *unsigned* variables. Unsigned variables don't store negative numbers, whereas signed variables do. The way this works requires a little bit of thinking about binary numbers.

An int is 32 binary values. Binary counting uses 1 and 0 to count instead of 0 through 9 like we're used to doing. This means that when you want to set a variable to 1, you'll actually be storing the value 1 in the place where the variable is stored. When you want to store the value 2, you'll be storing 10, which means 1 in the 2's place and nothing in the 1's place. Additionally, 3 is represented as 11, which means 1 in the 2's place and 1 in the 1's place, for $2+1$, which is 3. Further, 4 is represented as 100, which is 1 in the 4's place and nothing in the 2's or 1's place. Therefore, 16 is 1,000, 17 is 1,001, 18 is 1,010, and so on. This is called *two's complement math* because it counts everything up by squaring for the next value. That's a very quick introduction to binary math, but don't worry, there's a much more comprehensive discussion of this in several chapters later in this book where you begin using bits and binary.

Figure 2-1 shows the ways that signed and unsigned variables work. Remember that in C++ the int is 32 bits, so there will be 32 boxes to show what each bit stores.

In unsigned numbers, the first bit is counted like any other bit. In signed numbers, the first bit is used to store whether the number is positive or not, and this is why unsigned variables can store larger values than signed variables.

Arduino and C++ use unsigned variables, and all variables are signed unless you indicate otherwise by putting `unsigned` in front of the variable type:

```
unsigned int = 5;
```

Processing does not use unsigned variables; all numerical variables in Processing are signed.

In C++, the language you'll use with oF, signed ints are $-2,147,483,647$ to $2,147,483,647$, and unsigned ints are between 0 and $4,294,967,295$. In Arduino, the int can be between $-32,768$ to $32,767$. Tricky? Not really. Lots of times you won't have to think about what you're storing in the int. When you do have to think about how large the value you're going to be storing is, it's time to use a bigger number type, like long or double. We'll discuss these later in this section. When using Processing, you

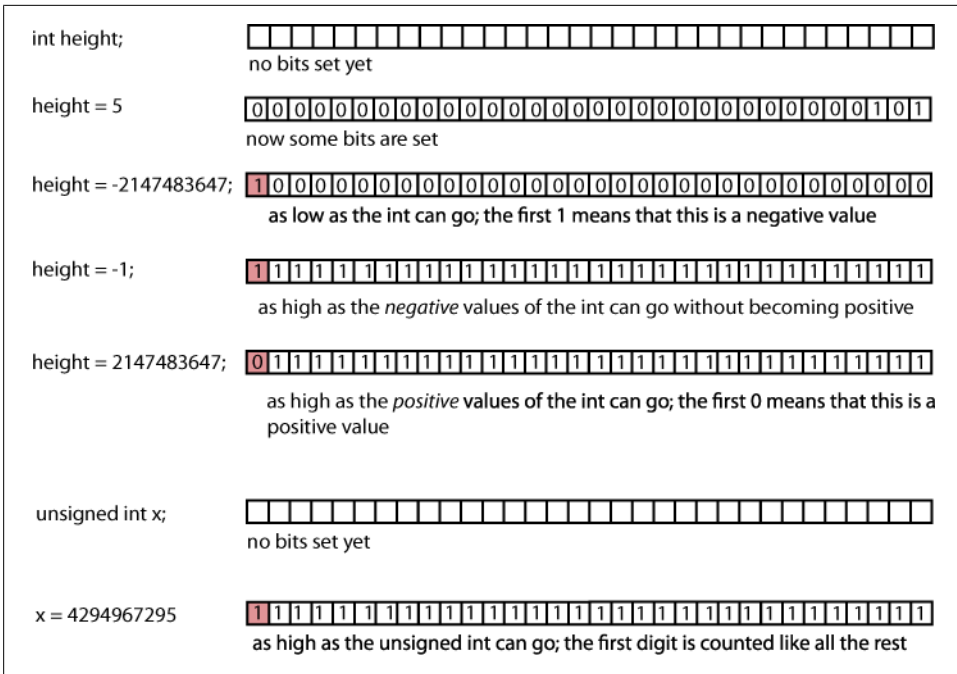

Figure 2-1. Setting the bits of signed and unsigned variables

never have to think about how large the value will be at all, so it isn't a problem. Simply figure out whether you'll need a decimal point. If you do, then use a float; if you don't, then use an int.

float

The *float* is the datatype for floating-point numbers, which are numbers that have a decimal point. Floating-point numbers are often used to approximate analog and continuous values because they have a greater range of values than integers. Signed float variables can be as large as 2,147,483,647 and as low as -2,147,483,647. Float variables aren't signed in C++ or Arduino.

char

This type can contain characters, that is, single letters or typographic symbols such as A, d, and \$. Here are two `char` variable declarations:

```
char firstLetter = 'a';
char secondLetter = 'b';
```

So, what is different about floats, ints, and chars? `char` variables can sometimes be added together like numbers, but it's not going to work the way you think it will. When working with Processing or Arduino, it's not going to work period, and with C++ in openFrameworks it will work, but not as you might expect:

```
char thirdLetter = a + b; // this won't become 'ab' or 'c'
```

Like I mentioned earlier, Processing and Arduino aren't going to like this at all. They're just going to throw errors at you and complain. C++, however, will work, and the next section will explain why.

ASCII

There are a few ways that characters in a computer are stored, and one way is as numbers in a system called American Standard Code for Information Interchange, or ASCII. In ASCII, a is 97, and b is 98. That's why if you run the following snippet of code through a C++ compiler or through Processing or Arduino, it'll happily say that c is 195:

```
char a = 'a';  
char b = 'b';  
int c = a+b; // notice that a+b is being stored as an int
```

You can store the result of two characters being added together *if you store the value of the result as an int* because adding the characters together is really adding the numbers that they are stored as together.

All keyboard-related things can be stored as a char. That includes particular keys on the keyboard. These are called *character escapes*, and they have a particularly special place in programming because this is how you determine when the user has clicked a key that can't be represented with a letter or number. There are other encoding systems that correlate numbers to letters, Unicode Transformation Format, or UTF, is a very popular one that you might hear mentioned. Encoding is a complex topic and the most important thing to understand is that the char is both a number and character.

bool or boolean

Boolean values store two possible values: **true** and **false**. In C++ and Arduino, the **true** is actually a 1, and the **false** is actually a 0. It's usually clearer to use **true** and **false**, but you can use 1 and 0 if you like. They're very handy for storing very simple results: you received a message from the server or you didn't, the user clicked the F key or they didn't.

For Arduino and Processing, you do the following:

```
boolean b = true;
```

In C++, you do this:

```
bool b = true;
```

Note that the Processing and Arduino version uses the word **boolean**, while C++ uses the word **bool**.

Both **true** and **false** are reserved words. That means that the compiler only recognizes them as being values that you can use to set Boolean variables. This means that you can't, for example, do this:

```
boolean true = false;
```

It will cause errors, which is something that, although unavoidable, you generally want to restrict to more interesting things that will help you create your projects.

string

A *string* is a sequence of characters. This is both a helpful, metaphorical way to think about it and a matter of fact, and it is something that you'll investigate more closely later. The string includes helpful methods for looking at individual characters, comparing strings to see whether they're the same or different, searching strings for parts of the string (for example, finding "toast" in "toaster"), and extracting parts of strings (getting "toast" out of "toaster"). The differences between a string and a char is that a string is always defined inside double quotes ("Abc") and can consist of multiple characters, while char variables are defined inside single quotes ('A') and can consist of only one character.

Here are some strings in Processing:

```
String f = "foo";  
String b = "bar";  
String fb = f+b;// this will be "foobar"
```

Here are some strings in C++:

```
string f = "foo";  
string b = "bar";  
string foobar = f+ " "+b;// this will be "foo bar" note the space w/in quotes
```

Note that Processing uses `String`, while C++ uses `string`. Why isn't there any Arduino example? Arduino doesn't have a `String` or a `string`, because it doesn't need one. We'll have to leave the explanation for this until the next section. Suffice to say, it's not a huge problem.

Since a `String` is defined within quotes:

```
String super = "super";
```

including quotes in a `String` requires the (backslash) character to be used preceding the quote:

```
String quoted = "He said \"It's super\"."
```

This is known as an *escape sequence*. Other escape sequences include `t` for the tab character, which is written `\t` with the escape character, and `n` for newline, which is written `\n`. A single backslash is indicated by `\\` because without the `\` in front, the compiler would think that you're writing an escape sequence. If you wanted to write the characters *\that's great!*, you'd write this:

```
String quoted = "\\that's great!";
```

Otherwise, without the double backslash, you'd end up with this:

```
"  hat's great!"
```

The compiler would assume that the `\t` is a tab.

byte

The *byte* is the datatype for bytes, that is, 8 bits of information storing numerical values. In Processing the byte stores values from -128 to 127 (a signed value), and in the Arduino it stores from 0 to 255 (an unsigned value). Bytes are a convenient datatype for sending information that can't or shouldn't be represented by strings or other kinds of numbers such as the contents of a file, data sent to or from hardware, data about the pixel of an image, or a millisecond of sound.

Here are bytes in Processing and Arduino:

```
byte firstByte = 55;  
byte newByte = 10+firstByte;
```

Now, the byte `newByte` is just a value waiting to have something done with it. If you were to treat `newByte` like a `char`, it would be A and if you treat it like an `int`, it would be 65. Because bytes are so lightweight, they often are used to represent data that needs to be read or written, or sent quickly, or as data that doesn't have an easy representation in other formats.

C++ does not have a byte type. Where you would use a byte in Processing or Arduino, you use a `char` in C++. Why is this? Remember that the `char` is an ASCII number value, that is, a number between either -128 and 127 or 0 through 255, that represents a letter or character. The designers of C++, taking a cue from the C programming language that preceded it, being as efficient as possible, recognized that this value could be used not only for characters but for anything. Hence, in C++ you use the `char` more frequently than in Processing or Arduino.

long

The long variable allows you to store very large nonfloating-point numbers, like an `int`. In C++ and Arduino, the long can store values from -2,147,483,648 to 2,147,483,647. In Processing, the maximum value is considerably larger: 18,446,744,073,709,551,615.

Arrays

The array is a slightly more complex datatype than the ones that were shown earlier. An *array* contains one or more variables in a list. Remember one of the problems that you're going to run into in this book is that there are three different programming platforms used in this book, each of which does things slightly differently. We'll look at three different arrays filled with integers in each of our platforms to give you a feel for the similarities and differences.

The array is a list of multiple elements; in the code snippet below, it will contain integers. You're going to create an array that holds three `int` values: 1, 2, 3. It's nothing too thrilling, but it's a good place to start.

Note the markers above each of the elements in the array in [Figure 2-2](#): `numbers[0]`, `numbers[1]`, `numbers[2]`. These are the array access operators. That’s not a typo; they do count up from 0. We’ll come back to these after we look at creating the array.

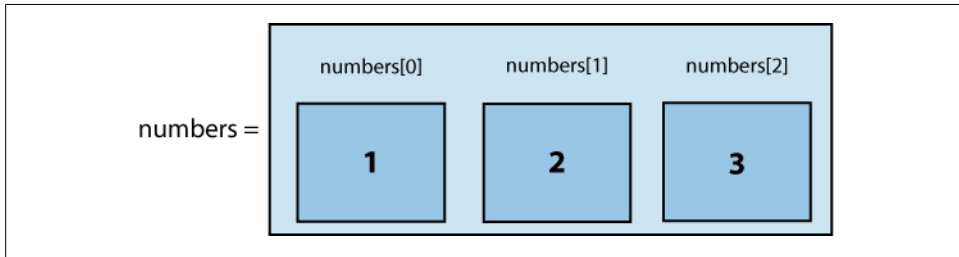

Figure 2-2. An array with three integers

Here’s what the array looks like in Processing:

```
int[] numbers = new int[3];
numbers[0] = 1;
numbers[1] = 2;
numbers[2] = 3;
```

First, look at the declaration of the array, as shown in [Figure 2-3](#).

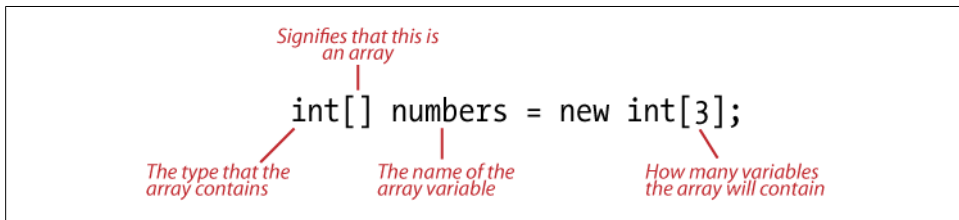

Figure 2-3. An array containing three integers as declared in Processing

You can declare arrays to be filled with any type, even types that you create yourself. We’ll get to this later. The code snippet sets all the values of the array. When you want to access an element in the array, you use the access operators, `[]` to access the index position in the array that is specified within the square brackets:

```
int x = numbers[0];
```

The following sets `x` to 1, because the first item in our `numbers` array is 1:

```
int y = numbers[1] + numbers[2];
```

The following sets `y` to the values of the second plus the third elements of `numbers`, that is, 2 plus 3, which equals 5. If you use the `=` operator in front of the array with the access operator, it sets the value of the element in the array at that point:

```
numbers[0] = 1;
numbers[0] = 5;
```

Whereas `numbers[0]` originally was 1, it is now 5. The array is really storage, and each element in the array is like a box that can store any variable of the type declared when the array is created. When any item within the array is set, it will store that value until it is changed.

Instead of putting each number into the array on a separate line of code, the array values can be created all at once:

```
int arr[] = {1, 2, 3};
```

or:

```
int arr[3] = {1, 2, 3};
```

Note that above the array does not need to have a number length assigned to it. This results in the same array as creating the array in the first example; however, it assumes that you know all the values that will go into the array. If you do not, use the first method described.

The next language to look at is the declaration of an array in Arduino. Luckily for the sake of brevity, the Arduino platform deals with arrays very similarly to Processing. Creating an array in Arduino or C++ can be done in any one of the three following ways.

Here's what the array looks like in Arduino or C++:

```
int arr[] = {1, 2, 3};
```

or:

```
int arr[3];
```

or:

```
int array[3] = {1, 2, 3};
```

Figure 2-4 breaks down the parts in the array.

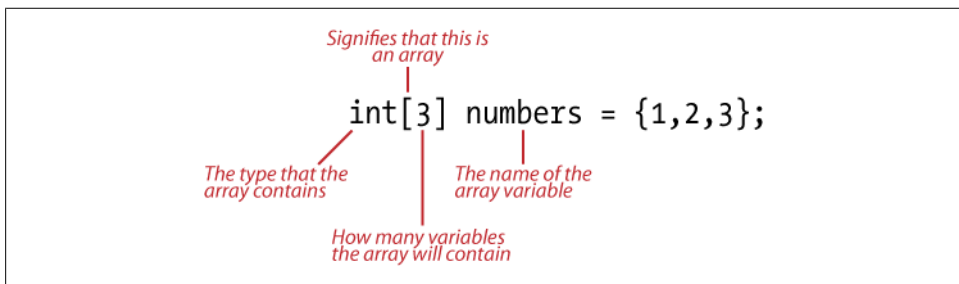

Figure 2-4. Creating an array in C++

The only difference between the array in Processing and in Arduino is that while Processing supports the `new` keyword when creating an array, Arduino does not. If you know all the elements when you're creating the array, do it like so:

```
int array[3] = {1, 2, 3};
```

Otherwise, you should construct an array like this:

```
int[] arr = new int[3];
```

Now that we've covered the basics of arrays, you'll look at some of the more complex aspects of dealing with the array. The first is the error that you're sure to encounter at some point, specifically, the "out of bounds access" error in all its many forms. What this means is that you've tried to access an element in the array that does not exist.

In Arduino and C++, arrays can be initialized as shown here:

```
char arr[3] = {'a', 'b', 'c'};
char badArrayAccess = arr[3];
```

When you try to do something with the `badArrayAccess` variable, you'll find that not only is it not a char, but that accessing it might just crash your program. This is because the array `arr` contains three char variables, and you're trying to access a fourth one, which violates the number of elements established when declaring the array. Another mistake is trying to store the wrong kinds of variables in the array, as shown here:

```
char arr[3]; // an array of chars, with space for 3 variables
float f = 2.3;
arr[0] = f; // oops! arr expects chars, so will turn f into "2"
bool b = true;
arr[1] = b; // oops! arr expects chars, so will convert b into "1"
```

This won't cause an error; however, it won't return the variables correctly, because the array declared is expecting char variables, so when you place float and bool variables within that array, it automatically converts them to char, with frequently unpredictable results. [Table 2-1](#) is a quick comparison of the datatypes and how the three languages use them.

Table 2-1. Comparison of datatypes

Arduino	Processing	C++	Use
int	int	int	A number without a decimal point, for example: 4 or -12
float	float	float	A number with a decimal point, for example: 1.23 or -128.12
char	char	char	A single character or number that will be treated as a character, for example: a, 1, !
None (use char[] instead)	String	string	A grouping of characters together, for example: hello, 172 Cherry Street
byte	byte	None (use char instead)	The value of a byte, between -128 and 127 if the byte is signed and 0 and 255 if it is not signed
boolean	boolean	bool	A true or false value
double (but same as float)	double	double	A floating-point number with higher precision than float

Casting

What do you do if you have a number that is an integer but you need it to be a float? You *cast* it. This means that you convert it from its original type into a new type:

Here's what casting looks like in Processing, Arduino, and C++:

```
int i = 5;
float f = (float)i; // float is now 5.0
```

Why can't you simply set `f` to `i`?

```
float f = i;
```

Types won't allow you to do that, because that's the point of a type. You know what specific type values are, how much memory they require, and how they can be used. The previous code will cause an error if you try to run it. Instead, cast the variable. You can't change the type of a variable once it's declared. In this example, `i` will always be an `int`, but if you need to use it as a float, you can very easily cast it. Some other examples of casting involving `char` variables because they are such a fundamental datatype. For instance, if you want to cast a `char` to a float and then back you do the following:

```
char ch = 'f';
int fAsInt = (int)ch; // now fAsInt is 102
char newChar = char(fAsInt); // newChar is now 'f'
```

One important thing to note is that you cannot cast an array:

```
char[] foo = {'a', 'b', 'c', 'd'};
int[](foo); // ERROR
```

To cast anything in an array, you need to cast every element of the array. We'll cover this in greater detail in the sections on loops, but for now, we'll look at this:

```
char[] foo = {'a', 'b', 'c', 'd'};
int i = int(foo[0]);
```

Here you create an array of `char` variables and then read one of those `char` values out of the array and cast it as an `int`.

Operators

Operators are the symbols that a compiler uses to perform commands and calculations in your program. Operators let you set variables like the `=` operator, compare variables like the `==` operator, add variables like the `+` operator, and so on. There are three major types of operators. The first operators are the mathematical operators that perform mathematical operations. These should be familiar from any math class you've ever taken. The second are assignment operators that change values. The third are comparison operators, which determine whether two variables are equal, different, greater than, or less than another variable.

Mathematical operators work pretty much as expected, with one notable exception. `+` adds two values, for example:

```
int apples = 5
int moreApples = apples + 3; // moreApples is equal to 8.
```

The exception occurs when you add strings; you end up with the two strings stuck together:

```
string first = "John";
string second = "Brown";
string full = first+second; // now full is JohnBrown
```

This is because of something called *operator overloading*. If you're curious enough, you can check some of the recommended programming books from [Chapter 18](#) for a full description, or look online because it's a more advanced topic.

The other simple mathematical operators are `-` (subtraction), `*` (multiplication), and `/` (division). The last mathematical operator is `%`, the modulo.

The modulo tells you what is left over (the *remainder*) when the value on the left is divided by the value on the right. Here are some examples:

```
8 % 2 // equals 0 since there's no remainder when 8 is divided by 2
17 % 2 // equals 1 since there's a remainder of 1 when 17 is divided by 2
19 % 5 // equals 4 since the remainder is 4 when 19 is divided by 5
12 % 11 // equals 1 since the a remainder of 1 when 12 is divided by 11
19.0 % 5 // equals 4.0 since we're dealing with floats
```

Assignment operators work from right to left. That is, the operator uses the value on the right to assign or change the variable on the left. For example:

```
int age = 6;
```

The `=` operator sets the variable on the left to 6. There are other types of assignment operators that change the value of the variable on the left, just like the `=` operator. For instance:

`+=`

Adds the value on the right to the value on the left:

```
int height = 6;
height += 1; // height is now 7
height += 10; // height is now 17
```

`-=`

Subtracts the value on the right from the variable on the left:

```
int size = 16;
size -= 8; // height is now 8
size -= 6; // height is now 2
```

`++` and `--`

Add one or subtract one from the variable on the left:

```

int hearts = 2;
hearts++; // hearts is now 3
hearts--; // hearts is now 2 again
hearts--; // hearts is now 1

```

*= or /=

These work roughly the same as the += and -= statements, multiplying or dividing the variable on the left by the value on the right:

```

int i = 15;
i /= 3; // i is now 5
int j = 20;
j /= 2; // j is now 10
float k = 100.0;
k /= 3.333333; // k is now 30.000004
float m = 100.0;
m /= '2'; // not a good idea
i *= 4; // i is now 20
m *= 0.5; // m was 2.0 and is now 1.0

```

Comparisons are very important in programming and particularly important in using control statements, which will be discussed in the next section. Before we get to that, though, you need to become familiar with the various operators. These operators are common across all the programming languages discussed in this book and, with slight variations, across all programming languages. Comparisons allow you to determine whether variables are the same, different, greater than, or less than one another:

== (equal to)

Compares whether two things are equal. For example:

```

5 == 4 // false
'a' == 'a' // true
(12 / 3) == (2 * 2); // true
4.1 == 4 // false
char(102) == int('f') // true, because 102 is 'f' in ASCII
"duck" == 0.002 // false, because it doesn't make any sense

```

!= (not equal to)

Checks whether things are not equal, for example:

```

3 != 1 //true, they're not equal
'B' != 'b' // also true, they're not equal

```

> (greater than)

Checks whether the value on the left is *greater* than the value on the right, just like in math class:

```

4 > 3 // true
5 > 192901.2 //false
"fudge" > 8 // false, because it doesn't make any sense

```

< (less than)

Checks whether the value on the left is *smaller* than the value on the right, again, just like in math class:

```
3 < 2 // false
'g' < 106 // since 'g' is 103 in ASCII this is true
-100 < 100 // true
```

>= (greater than or equal to)

Checks whether the value on the left is *greater than or equal to* the value on the right, just like in math class:

```
3 >= 3 // true, since they're equal
0 >= -0.001 // since 0 is greater than -0.001, this is true
'?' >= 'h' // true, since '?' is 63 in ASCII and 'h' is 104
4 >= 28 // false
"happy" >= "sad" // false, because it doesn't make any sense
```

<= (less than or equal to)

Checks whether the value on the left is *smaller than or equal to* the value on the right, again, just like in math class:

```
13.001 <= 13.001 // true, since they're equal
0 <= -0.001 // since 0 is greater than -0.001, this is false
'!' <= '7' // true, since '!' is 33 in ASCII and 'h' is 55
```

&&

Evaluates the statement on the left and the statements on the right and returns true if they are *both true*:

```
(4 > 3) && ('f' > '1') // true
((5 * 2) == 10) && ((6 - 3) != 4) // true
(5 < 10) && (2 > 4) // false, even though the left is true, the right isn't
```

||

Evaluates the statement on the left and the statements on the right and returns true if *either one of them is true*:

```
(4 < 3) || ('f' > 'e') // true, left isn't true but the right is
((5 * 2) == 10) || ((6 - 3) != 4) // both are true
('b'=='g') || (2 > 4) // false, none of them are true
```

You may be wondering what to do with all these evaluations and comparisons. The answer is control statements. [Table 2-2](#) lists operators and their uses.

Table 2-2. Operators and their uses

Operator	Use
+, -, *, /	Adds, subtracts, multiplies, and divides.
%	Modulo; returns the remainder of a division.
=	Assignment; assigns the value on the right to the variable on the left.
+=, -=, *=, /	Mathematical assignment; adds, subtracts, multiplies, or divides the value on the left by the value on the right and sets the value on the right to that result.
++	Adds 1 to the value to the left.
--	Subtracts 1 from the value to the right.

Operator	Use
<code>==</code>	Compares the value on the left with the value on the right. If they are equal, then the expression is <code>true</code> .
<code>!=</code>	Compares the value on the left with the value on the right. If they are not equal, then the expression is <code>true</code> .
<code>>, >=</code>	Compares the value on the left with the value on the right. If the value on the left is greater than or greater than or equal to the value on the right, the expression is <code>true</code> .
<code><, <=</code>	Compares the value on the left with the value on the right. If the value on the left is lesser than or greater than or equal to the value on the right, the expression is <code>true</code> .
<code>&&</code>	Checks the truth of the expression to the left of the operator and to the right; if both are true, the entire expression is <code>true</code> .
<code> </code>	Checks the expression to the left of the operator and to the right of the operator; if either is true, the entire expression is <code>true</code> .

Control Statements

You'll often want to control how the logic of your program flows. If one thing is `true`, then you'll want to do something different if it's `false`. You might also want to do something a certain number of times or until something becomes `false`. There are two kinds of control statements that you can use to create this kind of logic flow in your application: *conditional logic* statements, which check whether something is `true` or `false`, and *loop* statements, which do something a set number of times or until something becomes `false`.

if/then

The `if/then` is a conditional logic statement, and it works just like it does in English: "If it's raining, then I'll bring an umbrella." These statements look like this:

```
if(condition) {
    result if the condition is true
} else {
    result if the condition is false
}
```

There must be a `true/false` expression in the brackets next to the `if`. Here's an example:

```
int myWeight = 72;

if(myWeight > 100) {
    print(" you're getting heavy! ");
} else {
    print(" you're still doing ok ");
}
```

You can also use the `if` statement without an `else`:

```
int myHeight = 181;

if(myHeight > 200) {
```

```
    print(" you're too tall ");
}
```

This just means that the actions inside the brackets will execute if the statement is `true`; otherwise, you don't do anything. You can also check that things are not `true`:

```
boolean allDone = false;

if(!allDone) { // if not all done
    print(" keep going! ");
} else {
    print(" ok, quit! ");
}
```

There is one last permutation on this pattern:

```
if(age == 5){
    print(" you're 5!");
} else if(age == 25) {
    print(" you're 25!");
} else {
    print(" can't login "); // if neither of the above is true
}
```

In this example, there is a new term introduced, `else if`. What this does is evaluate another statement before going on to the `else` statement. This means that if the first statement doesn't evaluate to `true`, then check each `else if` looking for the first one that is `true`. If none is `true`, then do the `else` statement.

for Loop

The `for` statement lets us do things over and over again, for a specified number of repetitions. Loops are frequently used to loop through arrays and examine, use, or alter each element within them. This is going to be particularly useful when dealing with the pixels in images or frames of video, as well as sounds, data from the Internet, and many other kinds of information that needs to be sorted through:

```
int i;
for(i = 0; i < 10; i++) {
    print(char(i)+" "); // this will print 0, 1, 2, 3, 4, 5, 6, 7, 8, 9,
}
```

The `for` statement uses three different statements, as shown in [Figure 2-5](#).

The integer `i` is used to set the number of times that the loop will execute, running all the code inside the code block. In the initialization of the `for` loop, you set `i` to 0; as long as `i` is less than 10, you continue looping, and each time the `for` loop is passed, `i` is incremented by 1.

Of course, it is also entirely possible to use subtraction in the `for` loop:

```
for(int i = 5; i>-1; i--){
    print(i);
}
```

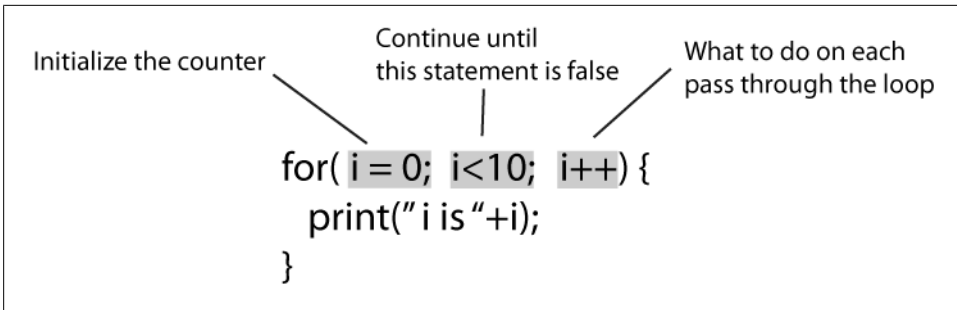

Figure 2-5. A for loop

Another great use of the for loop is to go through an array and look at each item in the array:

```
int[] intArr = {0, 1, 2, 3, 4, 5};
int sum = 0;
for(int j = 0; j < 6; j++){
    sum += intArr[j]; // we'll get the item in the array using the loop
}
```

Each time the loop executes, sum will be incremented using the next integer in the intArr array.

while Loop

The while loop is similar to the for loop, but it is slightly less sophisticated:

```
while(trueOrFalse){
    //something to do each time
}
```

As long as the expression that the while is evaluating each time through remains true, the loop will continue executing. This is important to note because if the evaluated variable does not become false, the loop will never exit, and your program could become locked up while the loop runs. Creating an *infinite loop*—that is, a loop that never exits—is easy and will certainly make your program unusable, so take care when using any of the control statements. Here’s an example using a counter, much like in the for loop:

```
int j = 0;

while(j < 100) {
    print(" what's up? "+j);
    j++; // if j is not incremented we end up with an infinite loop
}
```

Each time the loop executes, the integer j is incremented. When j is no longer less than 100, the loop is exited, and the program continues on:

```

boolean ready = false;
float number = 0.0;

while(ready != true) {
    print(" we're just waiting" );
    number += 0.1;
    if(number > 1.0){
        ready = true;
    }
}
print(" we're ready ");

```

In this example, you increment a number and use a second variable, a Boolean value, to determine whether you are in fact ready. Until the `ready` variable is `true`, the loop will continue executing, and the “we’re ready” message will not be printed.

continue

The `continue` statement tells a loop to skip over any further instructions and go on to the next repetition. For instance, if you wanted to loop through a certain number of items and process only odd numbers, you could do this:

```

for(int i = 0; i < 10; i++) {
    if( i % 2 == 0){
        continue;
    }
    println(i + " is not divisible by 2");
}

```

This will print the following:

```

1 is not divisible by 2
3 is not divisible by 2
5 is not divisible by 2
7 is not divisible by 2
9 is not divisible by 2

```

The `continue` statement here starts the loop over again. If you have a complicated operation to perform, then using the `continue` statement allows you to evaluate whether you need to run that operation and to skip it if you do not. This means your code does only what is necessary.

break

The `break` statement breaks the loop. It is a great tool to use when you’re looping through an array looking for something and suddenly you find it. Once you’ve found it, you can quit looping easily by using the `break` statement:

```

int[] intArr = {1, 2, 3, 4, 5, 6, 2, 12, 2, 1, 19, 123, 1, 3, 13};
int counter = 0;

while(counter < intArr.length)
{

```

```
    if(intArr[counter] == 5) { // we're looking for 5
        print(" found it at ");
        break;
    }
    counter++;
}
// code will continue from here after the break
print(counter); // found the value 5 in intArr[4]
```

Functions

What is a function?

A *function* is a name for a grouping of one or more lines of code and is somewhat like a variable in that it has a type and a name. It's very much unlike a variable in that it doesn't just store information; it manipulates it. Going back to the basic algebra analogy you saw earlier when first looking at variables, a variable is something like this:

x

A function is something more like an instruction with something that is given at the beginning of the instruction and something that is expected in return. Writing out a function in simple English, you might see something like this: "When someone gives you some money, add the amount given to you to the amount that you already have and report that number back to me."

There are a few parts there that can be broken out:

- An amount of money that you are given
- Adding the amount given to you to the amount that you already have
- Reporting that number

Those three things can be thought of in order as follows: what the function takes or what will be passed in to it, what it does, and what it returns. Functions are set patterns of behavior in your program that take certain kinds of values, do something with those values, and return something when they are finished.

Defining a Function

To turn the written example into code, you would define a variable to be used to keep track of all the money that you have:

```
int myBank = 0;
```

Then you create a function that takes money, adds it to `myBank`, and returns that value:

```
int moneyReceived(int money){
    myBank += money;
    return myBank;
}
```

Now, you have defined a function called `moneyReceived()`. Using pseudocode or talking through what a function is supposed to do can be quite helpful when trying to understand it. “Take an integer, add it to the money already in the bank, and return that value.” [Figure 2-6](#) is a diagram that helps walk you through what the function is supposed to do.

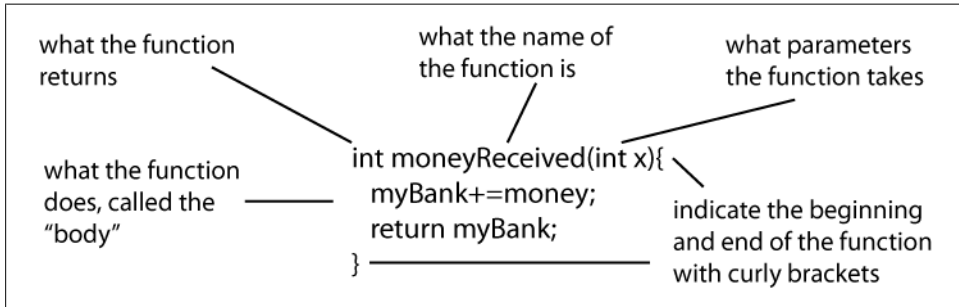

Figure 2-6. Declaring a function

Notice that the return statement is returning something that is of the same type as the type listed in front of the function name. The variable `myBank` is an `int` that the `moneyReceived()` function returns.

Passing Parameters to a Method

Once the function is defined, it’s time to call it. To call the function, you need to pass the correct kinds of parameters to it, which requires knowing what parameters the function requires. In the `moneyReceived()` function example, the required parameter is a single integer. Both of the following examples are legal:

```
moneyReceived(4);
```

or:

```
int priceOfDinner = 17;  
moneyReceived(priceOfDinner);
```

This next one is not legal:

```
float f = 1.32;  
moneyReceived(f);
```

because the variable being passed to the function is not the correct type. This is why being able to see the function declaration, that is, where its return type, name, and parameters are established, is so important.

The return statement indicates the type of value that the method will return, just as a type for a variable determines what kind of value the variable will store. Functions that don’t return anything are declared `void`, and any other kind of return value needs to be

declared. For example, if you created a function that would return a `char`, you would declare it like so:

```
char myFunction()
```

Note that the function always has the following pattern: type, function name, parentheses, and any parameters that need to be passed to the function:

```
int multiplyByTwo(int value){
    return value * 2;
}
```

This next function takes an integer value, multiplies that value by 2, and then returns whatever that value is. When a function has a return type, it can be used to set the values of variables:

```
int x = 5;
int twoTimesX = multiplyByTwo(x); // twoTimesX is now 10
```

Here, you use a function to return a `char` based on the value passed into the function:

```
char convertIntToChar(int i){
    char ch = char(i);
    return ch;
}
```

New variables can be set using the values returned from a function:

```
string addExclamationPoints(string s) {
    return s+"!!!";
}
string myStr = addExclamationPoints("hello"); // myStr will be 'hello!!!'
```

That's a bit tricky to see what's going on at first, but you simply have to understand that the function is going to become equal to a string when it's all done with its operations, which means that you can treat it like a string. Your program will take care of making sure that everything within the function will be run before it gets used to set the value of the variable.

That's why having functions typed is so important. Anything typed as an integer can be used to create a new integer:

```
int squareOfEight = square(8);
```

This will work if the `square()` function looks like this:

```
int square(int val) {
    return val*val;
}
```

Since `square()` returns an `int`, you can use it set an `int`. If it returned a float or another datatype, it wouldn't work, which makes reading and understanding the return types of functions so important.

Some Suggestions on Writing Functions

Name them well. Functions should do what their names indicate. A function called `square` is very well named if it takes an integer or float as a parameter and returns the square of that value. It's not so well named if it doesn't do that. Generally thinking of functions as verbs is a good way to go because it makes you think about what that thing should do in the first place and help you remember what you meant it to do later when you have to look back at it.

Make them no smaller than sensible and no larger than necessary. A function of 200 to 300 lines of code should probably be broken down into smaller functions. This helps you reuse different parts of the code in different places, where necessary, and helps you locate problems more quickly when they occur. Being able to isolate a problem to several lines of code instead of several hundred can save you hours.

When you find yourself needing to do the same tasks repeatedly, put the code into a function and call that function. For instance, if you are frequently resizing images and saving them to a folder somewhere online, you could make a function like this:

```
resizeAndSave(int picHeight, int picWidth, String urlToSave)
```

This cleans up your code, saves you typing, and makes debugging problems easier. The less stuff you have to look at, the more quickly you'll be able to find things, locate problems, and remember where you left off in a piece of code.

Overloading Functions

Function declarations are important for two reasons. First, the function declaration tells you what parameters to pass to the function and what kinds of things you can do with any values returned from a function. Second, the function declaration and the parameters that the function take are unique for the function that the compiler uses. A function that accepts two strings is considered different from a function that accepts three strings, *even if those functions have the same name*. Making multiple functions with the same name that accept different parameters allows you to use the same functionality to handle different situations. This is called *overloading* a method, allowing it to accept multiple sets of parameters.

Think of a verb like "draw." It's easy for us to differentiate between "drawing a picture" and "drawing a card" because of the context. The compiler treats functions that same way, which makes it easier for us to name functions with the same functionality by the same name and rely on the compiler to differentiate between them using the context of the kinds of parameters passed. Sizes for a video could be set using int values or float values, for example. The compiler considers each of these functions to be completely separate, even if they have the same name. When the function is called, if float values are passed, then the function of that name that accepts floats is used.

Here is an example of an overloaded function in Processing:

```

char multiplyByTwo(char value){
    return char(int(value) * 2);
}

String multiplyByTwo(String value) {
    return value+value;
}

int multiplyByTwo(int value){
    return value * 2;
}

int[] multiplyByTwo(int value[]){
    for(int i = 0; i<value.length; i++) {
        value[i] *= 2;
    }
    return value;
}

```

This function accepts an int, a String, a char, and an array of ints (`int[]`). The version of the function that will be called is dependent on what is passed to it.

Here it is in Processing:

```

println(multiplyByTwo('z')); // this will print 6
println(multiplyByTwo(5)); // this will print 10
println(multiplyByTwo("string")); // this will print stringstring
int[] foo = {1, 2, 3, 4};
println(multiplyByTwo(foo)); //this will print 2, 4, 6, 8

```

Overloading functions is a great tool because it allows you to make a single way to do something and modify it slightly to take different kinds of variables as parameters. One thing to note is that although having different types of parameters, as shown here, is fine:

```

int function(int i) {
}

int function(float f) {
}

int function(char c) {
}

```

having different return types does not always work:

```

int function(int i) {
}

float function(float f) {
}

char function(char c) {
}

```

This will throw an error in Arduino and C++ but not in Processing. Generally, it's not the best idea, but it's your code, your project, and your call.

Objects and Properties

So, what's an object? An *object* is a grouping of multiple properties into a single thing that represents all those different properties. That sounds wretchedly abstract, but it's actually quite simple: think of a chair. A chair has a height, a weight, and a number of legs. So, those are three different properties of a thing called a chair. If you were to think about how you'd represent that in code, you'd probably say something like this:

```
Chair myChair;  
myChair.height = 22;
```

See the dot (.) after the name of the `Chair` instance but before the property? That's the *dot operator*, and in a lot of the most popular programming languages today it's the way that you access the properties of an object to use or set them. Let's look more at what to do with the chair:

```
myChair.legs = 4;  
myChair.weight = 5;
```

So, now you've made a chair called `myChair` that has some different properties: `legs`, `weight`, and `height`. Well, that's not particularly useful. Let's think of something that might be a little bit more useful to you. The following code snippets will all be using Processing:

```
PImage img = loadImage("mypicture.jpg");  
image(img, 20, 10);  
img.x = 300; // set the x position of the image  
img.y = 300; // set the y position of the image
```

The previous code might be a little mysterious at first, but let's look at the parts that you can make sense of right away. `PImage` is an object in Processing that lets you load and display image files, resize them, and manipulate their pixels. The explanation of all that needs to wait until the next chapter, which focuses on the Processing language. For the moment, you want to focus on these two lines:

```
img.x = 300; // set the x position of the image  
img.y = 300; // set the y position of the image
```

What you know after looking at these lines is that the `PImage` has an `x` property and a `y` property. So, when you create a `PImage` object, like our `img` object created in the previous code snippet, you can get or set those properties. That means that you can tell the object where the image should be, or you can find out where the image is. It all depends on which side of the equals sign you're placing the image on:

```
int xPosition = img.x; // get the image x position  
img.x = 400; // set the image x position
```

Now, let's look at another thing that an image can do, which is copy all of its pixels and return them to be used by another image. The `PImage` does this by using the `copy` function. Let's take a look at calling that function:

```
img.copy();
```

Notice the `.` operator there again? Just like the properties, the `.` operator is how you call functions as well. You might think that's confusing, but it's actually sort of helpful. The `.` indicates that you're using something within that object. So, the `PImage` `copy` function is another property of the `PImage`, just one that happens to be a function.



Methods versus functions: usually functions that are part of something like the `PImage`—for instance, `copy`—are called *methods*. The difference between them is mostly semantic and isn't something you should worry about. Just remember that if you see the term *method*, it's referring to a function that belongs to an object like `PImage`.

Now, if you happen to look at the documentation for the `copy` function on the Processing website, you'll see something that looks like [Figure 2-7](#).

Class	<code>PImage</code>
Name	<code>copy()</code>
Examples	 <pre>PImage img = loadImage("tower.jpg"); img.copy(50, 0, 50, 100, 0, 0, 50, 100); image(img, 0, 0);</pre>
Description	<p>Copies a region of pixels from one image into another. If the source and destination regions aren't the same size, it will automatically resize source pixels to fit the specified target region. No alpha information is used in the process, however if the source image has an alpha channel set, it will be copied as well.</p> <p>The <code>imageMode()</code> function changes the way the parameters work. For example, a call to <code>imageMode(CORNERS)</code> will change the width and height parameters to define the x and y values of the opposite corner of the image.</p>
Syntax	<pre>img.copy(sx, sy, swidth, sheight, dx, dy, dwidth, dheight); img.copy(srcImg, sx, sy, swidth, sheight, dx, dy, dwidth, dheight);</pre>

Figure 2-7. The documentation for the `PImage` `copy` from [Processing.org](#)

So, what does this tell you? It shows you an example of using the `PImage copy`, and it shows you what the signature of the function looks like. Here it is in Processing:

```
img.copy(sx, sy, swidth, sheight, dx, dy, dwidth, dheight);  
img.copy(srcImg, sx, sy, swidth, sheight, dx, dy, dwidth, dheight);
```

This tells you that the `PImage` has a function called `copy` that has two different ways it can be called. You'll need to read the rest of the `PImage` documentation on the Processing website to know what parameters you need to pass to each of these functions, but the names of those parameters should be somewhat helpful. Looking at the documentation shown in [Figure 2-7](#) for the first function, you see several parameters with an `s` appended to them and several with a `d` appended to them. The `s` stands for source, and the `d` stands for destination, making them a little easier to understand. The function copies the pixels from one `PImage` object to another `PImage` object. Now that you have a rough idea of what sorts of parameters these functions take, you can call them on two different `PImage` objects:

```
PImage p1 = loadImage("baby.jpg");  
image(p1, 0, 0);  
PImage p2 = new PImage(400, 400);  
p2.copy(p1, 0, 0, p1.width, p1.height, 10, 10, p1.width * 2, p1.height * 2);  
image(p2, 100, 100);
```

Take a moment to read the fourth line carefully. You're calling a function on the `p2` `PImage`, on `p2`, and passing the height and width of `p1` as parameters. Let's look at that function signature one more time:

```
img.copy(srcImg, sx, sy, swidth, sheight, dx, dy, dwidth, dheight);
```

`srcImg` is the `PImage` you want to copy pixels from, and `sx` and `sy` are where you want to copy the image from. `dx` and `dy` is where the image will be copied to and how wide and high the image will appear. You can use the properties of a `PImage` to pass values to a function of another `PImage`. You'll see this quite frequently, where properties of objects are stored, passed around, and accessed later.

Let's imagine for a moment that you've made some object that has a whole bunch of `PImage` objects inside it. You'll call it a `PhotoAlbum`. That object has a function on it called `getNewestPicture`. In using your `PhotoAlbum` class, you might have something that looks like this in Processing:

```
PhotoAlbum newAlbum;  
newAlbum.getNewestPicture().filter(BLUR);
```

So, even though we haven't covered the `filter` function, I'd bet you can guess what doing `filter(BLUR)` will do. The interesting thing to note here is how a value from the `getNewestPicture` function has another function called on it right away. You could just as easily say this in Processing:

```
PhotoAlbum newAlbum;  
PImage img = newAlbum.getNewestPicture();  
img.filter(BLUR);
```

The two code snippets here will do exactly the same thing, but they'll do them in slightly different ways. It isn't important which way you do these things; it's only important that you're able to follow both the ways that they're done because you'll encounter them both.

Scope

Scope is one of those nefarious things that can create some of the most mysterious bugs known. Luckily for you, it's quite easy to keep it straight because there's a simple rule that will keep you out of trouble.

Let's first look at the following little Processing code snippet:

```
void setup() {  
    if(true)  
    {  
        int i = 0;  
    }  
    i+=1;  
    print(i);  
}
```

OK, that was rather pointless, but if you try to compile it, you'll see something interesting pop up above the Processing console window (we'll cover how to do that in [Chapter 3](#)). You'll see this:

```
Cannot find anything named "i"
```

What was that? The scope of something means the place in your program where things are accessible. [Figure 2-8](#) shows where in the function that each variable is accessible.

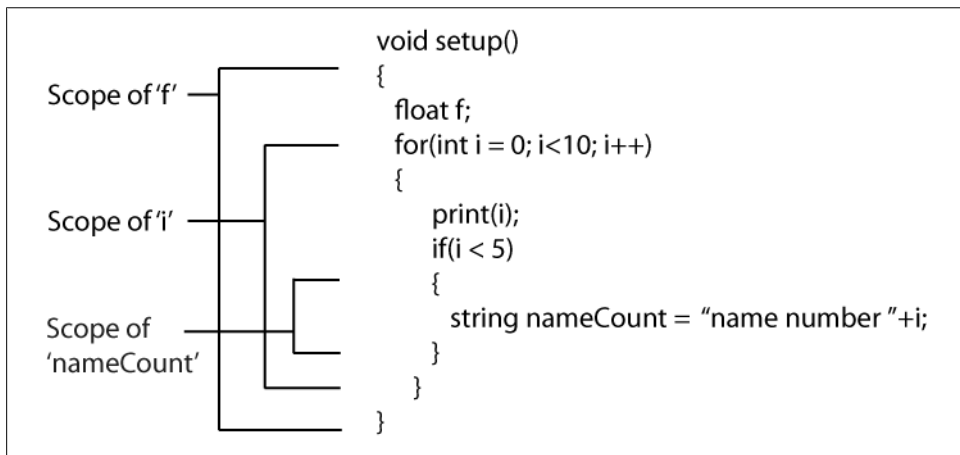

Figure 2-8. Variable scope throughout a short function

The general rule of variable scope is this: *all variables exist within the brackets that surround them*. If you have a variable within a function, you have this:

```
void someFunction() {
    int anInt;
}
```

The variable `anInt` is going to exist in that function, until the closing bracket for the function, which is the `}` at the end of the function. If a variable is defined within an `if` statement, then you have this:

```
if(something) {
    int anInt;
}
anInt = 5; // can't do this! anInt doesn't exist out here
```

In this case, `anInt` exists only inside that `if` statement, not anywhere else. Why is this? The short answer is that it makes it easier for your program to figure out what things are being used and what things aren't so that it can run more efficiently. Just remember the rule of the brackets: if there's a bracket before a variable, it exists only until another bracket closes it.

Some variables are available everywhere in a program, so they never go out of scope. These kinds of variables are called *global variables*. In a Processing or Arduino application, you can create a global variable by declaring it outside of the `setup()` method of your application. In an `oF` application, it's a little different to do. You'll learn more about variables and global variables in each chapter relating to the specific language that you'll be looking at, because each one handles them in a slightly different fashion.

Review

Variables represent data stored in the computer's memory for your program to access.

Variables have a type that describes what kind of information can be stored in them and specified when the variable is declared, for instance:

```
int weight = 150;
```

or:

```
float f = 1.12;
```

Variables are *declared* and then *initialized*. These can be done in separate steps:

```
int apples;
apples = 5;
```

or at the same time:

```
int apples = 5;
```

Variables can be cast to another variable type by using the name of the new type and parentheses to cast the variable:

```
float f = 98.9;
int myInt = int(f); //myInt is now the float f converted into an int
```

All variable types can be stored in arrays. These are declared with the length of the array and the type of variable stored in the array:

```
int arr[6]; // creates an array that can hold up to 6 integers
```

Accessing an array at any point within it is done by using the index, which begins at 0 and extends to the length of the array minus 1:

```
arr[0] = 1;
arr[1] = 2;
print(arr[0]); // will print '1', the first element in the array
```

Arrays can be filled when they are declared, as shown here:

```
int arr[3] = {1, 2, 3};
```

or the elements in the array can be set one at a time.

Control structures allow you to control the flow your program. The most commonly used control structure are branching structures:

```
if(somethingTrueOrFalse){
    //if the evaluated statement is true
} else {
    //if the evaluated statement is false
}
```

and loops:

```
for(int i = 0; i<someNumber; i++) {
    //do something someNumber of times
}
```

Functions are declared with a name, a return type, and any parameter that the function requires:

```
returnType functionName(parameterType parameterName) {
    //what the function does
}
```

Using a function is usually referred to as *calling* the function. This is separate from *declaring* the function:

```
splitString(0, 10, 'hello there'); // this calls the function declared above
```

Functions can be overloaded, which means that multiple method declarations can be made with the same name and different parameters. When you call one of the functions, the compiler will determine which version of the function you meant to call.